

SIXBAR 1000™

user manual

ELATION | SIXBAR 1000™ | user manual

©2019 ELATION PROFESSIONAL all rights reserved. Information, specifications, diagrams, images and instructions herein are subject to change without notice. ELATION PROFESSIONAL logo and identifying product names and numbers herein are trademarks of ELATION PROFESSIONAL. Copyright protection claimed includes all forms and matters of copyrightable materials and information now allowed by statutory or judicial law or hereinafter granted. Product names used in this document may be trademarks or registered trademarks of their respective companies and are hereby acknowledged. All non-ELATION brands and product names are trademarks or registered trademarks of their respective companies.

ELATION PROFESSIONAL and all affiliated companies hereby disclaim any and all liabilities for property, equipment, build ing, and electrical damages, injuries to any persons, and direct or indirect economic loss associated with the use or reliance of any information contained within this document, and/or as a result of the improper, unsafe, insufficient and negligent assembly, installation, rigging, and operation of this product.

Elation Professional USA | 6122 S. Eastern Ave. | Los Angeles, CA. 90040
323-582-3322 | 323-832-9142 fax | www.elationlighting.com | info@elationlighting.com

Elation Professional B.V. | Junostraat 2 | 6468 EW Kerkrade, Netherlands
+31 45 546 85 66 | +31 45 546 85 96 fax | www.elationlighting.eu | info@elationlighting.eu

⚠ CAUTION
HIGH INTENSITY ULTRAVIOLET LIGHT



**AVOID DIRECT EYE & SKIN EXPOSURE.
WEAR PROPER EYE & SKIN PROTECTION.
SEE MANUAL FOR SAFETY INSTRUCTIONS.**

**RISK GROUP 3 - RISK OF EXPOSURE TO ULTRAVIOLET (UV) RADIATION!
FIXTURE EMITS HIGH INTENSITY WAVELENGTH OF ULTRAVIOLET LIGHT
WEAR PROPER EYE AND SKIN PROTECTION.
AVOID PROLONGED PERIODS OF EXPOSURE.
AVOID WEARING WHITE COLOR CLOTHING AND/OR USING (UV) PAINTS ON SKIN.
AVOID DIRECT EYE AND/OR SKIN EXPOSURE AT DISTANCES SHORTER THAN 11 feet (3.3m).**

**DO NOT OPERATE FIXTURE WITH DAMAGED/MISSING EXTERNAL COVER PROTECTIVE LENS. DO NOT LOOK DIRECTLY INTO THE (UV) LIGHT AND/OR VIEW (UV) LIGHT DIRECTLY WITH OPTICAL INSTRUMENTS THAT MAY CONCENTRATE THE LIGHT/RADIATION OUTPUT.
INDIVIDUALS SUFFERING FROM A RANGE OF EYE CONDITIONS, SUNLIGHT EXPOSURE DISORDERS, OR INDIVIDUALS USING PHOTSENSITIVE MEDICATION, MAY RECEIVE DISCOMFORT IF EXPOSED TO THE ULTRAVIOLET (UV) LIGHT EMITTED FROM THIS FIXTURE.**

DOCUMENT VERSION



Please check www.elationlighting.com for the latest revision/update of this manual.

Date	Document Version	Software Version	DMX Channel Modes	Notes
3/2015	1	≥1.06	6 / 7 / 11 / 13 / 36 / 72 / 75 / 79	Initial release.
4/2019	1.1	N/C	N/C	Update UV warning.

CONTENTS

General Information	4
Warranty	6
Safety Instructions	7
General Guidelines	8
Fixture Overview	9
Fixture Installation	10
Understanding DMX	12
Fixture Menu	16
DMX Channel Functions And Values	22
Cleaning and Maintenance	32
Technical Specifications	33
Optional Accessories	35

GENERAL INFORMATION

INTRODUCTION

Congratulations, you have just purchased one of the most innovative and reliable lighting fixtures on the market today! The **SIXBAR 1000™** has been designed to perform reliably for years when the guidelines in this booklet are followed. Please read and understand the instructions in this manual carefully and thoroughly before attempting to operate this unit. These instructions contain important information regarding safety during use and maintenance.

UNPACKING

Thank you for purchasing the **SIXBAR 1000™** by Elation Professional®. Every **SIXBAR 1000™** has been thoroughly tested and has been shipped in perfect operating condition. Carefully check the shipping carton for damage that may have occurred during shipping. If the carton appears to be damaged, carefully inspect your unit for damage and be sure all accessories necessary to operate the unit have arrived intact. In the event damage has been found or parts are missing, please contact our customer support team for further instructions. Please do not return this unit to your dealer without first contacting customer support at the number listed below. Please do not discard the shipping carton in the trash. Please recycle whenever possible.

BOX CONTENTS

- (1) powerCON Cable
- (1) Frost Filter
- (1) Glare Shield
- (3) Frost Filter/Glare Shield Mounting Screws
- Manual & Warranty Card

CUSTOMER SUPPORT

Elation Professional® provides a customer support line, to provide set up help and to answer any question should you encounter problems during your set up or initial operation. You may also visit us on the web at www.elationlighting.com for any comments or suggestions. For service related issue please contact Elation Professional®.

ELATION SERVICE USA - Monday - Friday 8:00am to 5:00pm PST

Voice: 323-582-3322

Fax: 323-832-9142

E-mail: support@elationlighting.com

ELATION SERVICE EUROPE - Monday - Friday 08:30 to 17:00 CET

Voice: +31 45 546 85 30

Fax: +31 45 546 85 96

E-mail: support@elationlighting.eu

WARRANTY REGISTRATION

Please fill out the enclosed warranty card to validate your purchase. All returned service items whether under warranty or not, must be freight pre-paid and accompany a return authorization (R.A.) number. The R.A. number must be clearly written on the outside of the return package. A brief description of the problem as well as the R.A. number must also be written down on a piece of paper and included in the shipping container. If the unit is under warranty, you must provide a copy of your proof of purchase invoice. Items returned without a R.A. number clearly marked on the outside of the package will be refused and returned at customer's expense. You may obtain a R.A. number by contacting customer support.

IMPORTANT NOTICE!



There are no user serviceable parts inside this unit. Do not attempt any repairs yourself; doing so will void your manufactures warranty. Damages resulting from modifications to this fixture and/or the disregard of safety and general user instructions found in this user manual void the manufactures warranty and are not subject to any warranty claims and/or repairs.

LIMITED WARRANTY

A. Elation Professional® hereby warrants, to the original purchaser, Elation Professional® products to be free of manufacturing defects in material and workmanship for a period of two years (730 days), and Elation Professional® product rechargeable batteries to be free of manufacturing defects in material and workmanship for a period of six months (180 days), from the original date of purchase. This warranty excludes discharge lamps and all product accessories. This warranty shall be valid only if the product is purchased within the United States of America, including possessions and territories. It is the owner's responsibility to establish the date and place of purchase by acceptable evidence, at the time service is sought.

B. For warranty service, send the product only to the Elation Professional® factory. All shipping charges must be pre-paid. If the requested repairs or service (including parts replacement) are within the terms of this warranty, Elation Professional® will pay return shipping charges only to a designated point within the United States. If any product is sent, it must be shipped in its original package and packaging material. No accessories should be shipped with the product. If any accessories are shipped with the product, Elation Professional® shall have no liability what so ever for loss and/or damage to any such accessories, nor for the safe return thereof.

C. This warranty is void if the product serial number and/or labels are altered or removed; if the product is modified in any manner which Elation Professional® concludes, after inspection, affects the reliability of the product; if the product has been repaired or serviced by anyone other than the Elation Professional® factory unless prior written authorization was issued to purchaser by Elation Professional®; if the product is damaged because not properly maintained as set forth in the product instructions, guidelines and/or user manual.

D. This is not a service contract, and this warranty does not include any maintenance, cleaning or periodic check-up. During the periods as specified above, Elation Professional® will replace defective parts at its expense, and will absorb all expenses for warranty service and repair labor by reason of defects in material or workmanship. The sole responsibility of Elation Professional® under this warranty shall be limited to the repair of the product, or replacement thereof, including parts, at the sole discretion of Elation Professional®. All products covered by this warranty were manufactured after January 1, 1990, and bare identifying marks to that effect.

E. Elation Professional® reserves the right to make changes in design and/or performance improvements upon its products without any obligation to include these changes in any products theretofore manufactured.

F. No warranty, whether expressed or implied, is given or made with respect to any accessory supplied with the products described above. Except to the extent prohibited by applicable law, all implied warranties made by Elation Professional® in connection with this product, including warranties of merchantability or fitness, are limited in duration to the warranty periods set forth above. And no warranties, whether expressed or implied, including warranties of merchantability or fitness, shall apply to this product after said periods have expired. The consumer's and/or dealer's sole remedy shall be such repair or replacement as is expressly provided above; and under no circumstances shall Elation Professional® be liable for any loss and/or damage, direct and/or consequential, arising out of the use of, and/or the inability to use, this product.

G. This warranty is the only written warranty applicable to Elation Professional® products and supersedes all prior warranties and written descriptions of warranty terms and conditions heretofore published.

SAFETY INSTRUCTIONS



The **SIXBAR 1000™** is an extremely sophisticated piece of electronic equipment. To guarantee a smooth operation, it is important to follow the guidelines in this manual. The manufacturer of this device will not accept responsibility for damages resulting from the misuse of this fixture due to the disregard of the information printed in this manual.



This device falls under **PROTECTION CLASS 1**. It's essential this device be grounded properly. Only qualified personnel should perform all electrical connections.



KEEP THIS FIXTURE AWAY FROM RAIN AND MOISTURE!



UNPLUG POWER BEFORE SERVICING FIXTURE



NEVER TOUCH FIXTURE DURING OPERATION AS IT MAY BE HOT



**NEVER LOOK DIRECTLY INTO THE LIGHT SOURCE
SENSITIVE PERSONS MAY SUFFER AN EPILEPTIC SHOCK**

- For proper operation, follow the **Installation** guidelines described in this manual. Only qualified and certified personnel should perform installation of this fixture and only the original rigging parts (brackets) included with this fixture should be used for installation. Any modifications will void the original manufacturer's warranty and increase the risk of damage and/or personal injury.
- Never look directly into the light source of this fixture to prevent risk of injury to your retina, which may induce blindness. Those suffering from **EPILEPSY** should avoid looking directly into the light source of this unit at all times.
- The fan and air inlets must remain clean and never blocked. Allow approx. 6" (15cm) between this fixture and other devices or a wall for proper cooling.
- Always disconnect from main power source before performing any type of service and/or cleaning procedure. Only handle the power cord by the plug end, never pull out the plug by tugging the wire portion of the cord.
- Do not operate this fixture if the power cord has become frayed, crimped and/or damaged. If the power cord is damaged, replace it immediately with a new one of similar power rating.

GENERAL GUIDELINES

- **NEVER OPEN THIS FIXTURE WHILE IN USE!**
- During the initial operation of this fixture, a light smoke or smell may emit from the interior of the fixture. This is a normal process and is caused by excess paint in the interior of the casing burning off from the heat associated with the lamp and will decrease gradually over time.
- This fixture is a professional lighting effect designed for **INDOOR / DRY LOCATIONS ONLY** on stage, in nightclubs, theatres, etc.
- Please make sure there are **NO FLAMMABLE MATERIALS** close to the fixture while operating, to prevent any fire hazard.
- The fixture must be installed in a location with adequate ventilation, at least 1.5 feet (.5m) from adjacent surfaces. Be sure no air ventilation slots are blocked.
- **DO NOT** attempt installation and/or operation without knowledge how to do so.
- **DO NOT** permit operation by persons who are not qualified to operate this type of fixture. Most damages are the result of operations by nonprofessionals.
- Consistent operational breaks may ensure the fixture will function properly for many years to come.
- **DO NOT** shake fixture, avoid brute force when installing and/or operating fixture.
- Always install the fixture with an appropriate safety cable. When installing the fixture in a suspended environment, always use mounting hardware that is no less than M10 x 25 mm, also be sure the hardware is insert in the pre-arranged screw holes in the bracket of the fixture.
- Use the original packaging and materials to transport the fixture in for service.
- **DO NOT TOUCH** the housing bare-hand during its operation. Turn OFF the power and allow approximately 15 minutes for the fixture to cool down before replacing or serving.

FIXTURE OVERVIEW

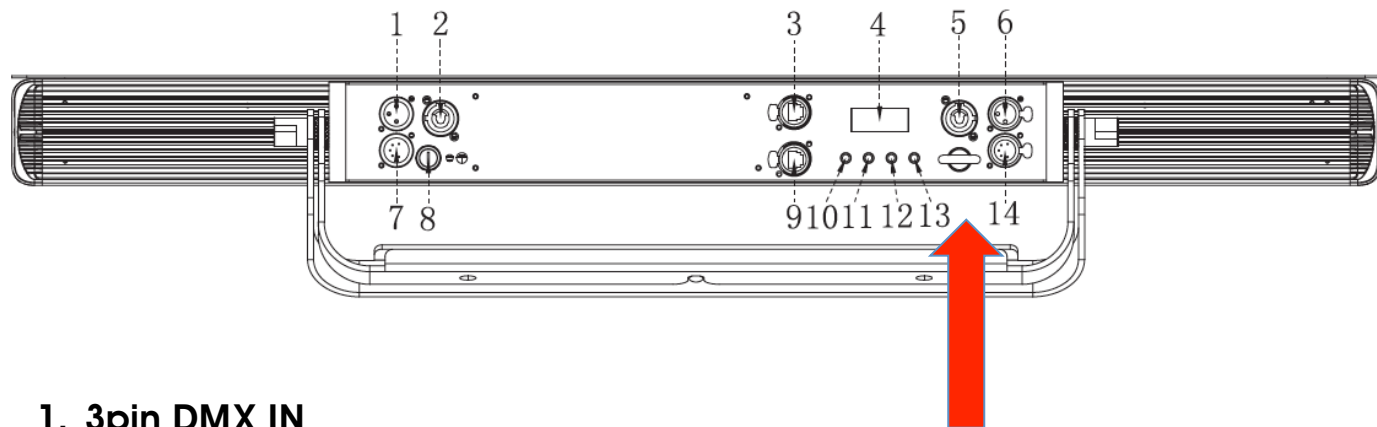

1. 3pin DMX IN
2. powerCON IN
3. RJ45 NET IN
4. LCD Menu Control Display
5. powerCON OUT
6. 3pin DMX OUT
7. 5pin DMX IN
8. FUSE
9. RJ45 NET OUT
10. Mode Button
11. UP Button
12. DOWN Button
13. ENTER Button
14. 5pin DMX OUT

**SAFETY CABLE
RIGGING POINT**

FIXTURE INSTALLATION



FLAMMABLE MATERIAL WARNING

Keep fixture at least 5.0 ft. (1.5m) away from any flammable materials, decorations, pyrotechnics, etc.



ELECTRICAL CONNECTIONS

A qualified electrician should be used for all electrical connections and/or installations.



CAUTIONS

- For added protection, mount the fixture in areas outside walking paths, seating areas, or in areas where unauthorized personnel might reach the fixture.
- Ambient operating temperature range for this fixture is **5°F to 113°F (-15°C to 45°C)**. Do not use the fixture under or above this temperature.
- Before mounting the fixture to any surface, make sure the installation area can hold a minimum point load of 10 times the weight of the fixture. **(160 lbs / 73 kg)**
- Fixture installation must always be secured with a secondary safety attachment, such as an appropriate safety cable.
- Never stand directly below the device when mounting, removing or servicing.



POWER LINKING

Max number of units that can be power linked is **6 units @110V** and **15 units @240V**.

CLAMP MOUNTING

The **SIXBAR 1000™** includes integrated dual floor stand/rigging yokes. When mounting this fixture to truss be sure to secure an appropriately rated clamps to the yokes using a M10 screw fitted through the center hole.

MOUNTING POINTS

- Overhead mounting requires extensive experience, including amongst others calculating working load limits, installation material being used, and periodic safety inspection of all installation material and the device. If you lack these qualifications, do not attempt the installation yourself. Improper installation can result in bodily injury.
- Fixture is fully operational in the specific mounting positions as illustrated below.

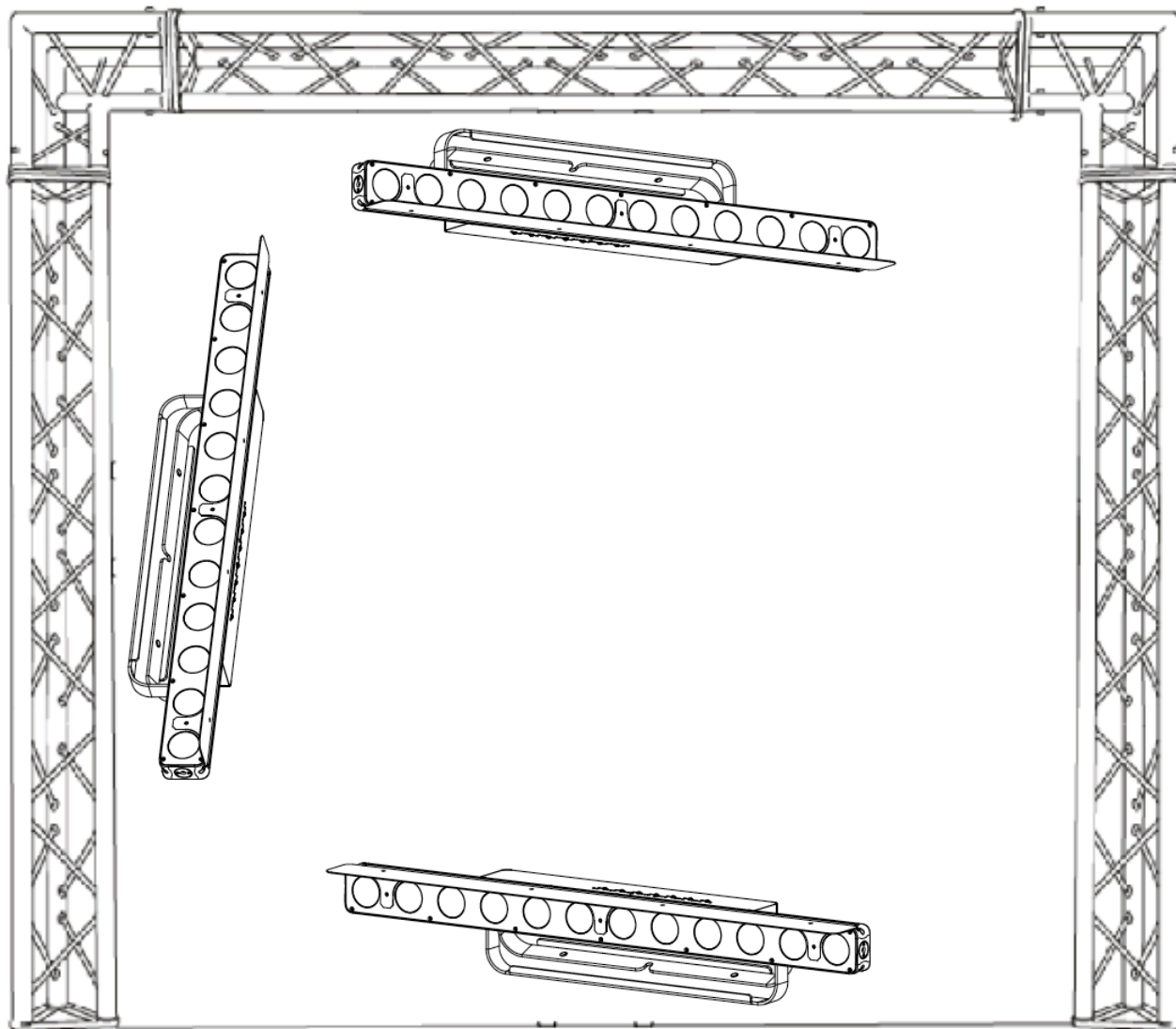

SAFETY CABLE

Always use a Safety Cable whenever installing this fixture in a suspended environment to ensure the fixture will not drop if the clamp fails.

UNDERSTANDING DMX

DMX-512

DMX is short for Digital Multiplex. This is a universal protocol used by most lighting and controller manufactures as a form of communication between intelligent fixtures and controllers. DMX allows all makes and models of different manufactures to be linked together and operate from a single controller. This is possible as long as all the fixtures and the controller are DMX compliant. A DMX controller sends the DMX data instructions to the fixture allowing the user to control the different aspects of an intelligent light. DMX data is sent out as serial data that travels from fixture to fixture via data "IN" and data "OUT" XLR terminals located on the fixtures (most controllers will only have output jacks).

DMX LINKING

To ensure proper DMX data transmission, always use proper DMX cables and a terminator. When using several DMX fixtures try to use the shortest cable path possible. Never split a DMX line with a "Y" style connector. The order in which the fixtures are connected in a DMX line does not influence the DMX addressing. For example; a fixture assigned a starting DMX address of 1 may be placed anywhere in the DMX chain, at the beginning, at the end, or anywhere in the middle. The DMX controller knows to send data assigned to address 1 to that fixture no matter where it is located in the DMX chain. The **SIXBAR 1000™** can be controlled via DMX-512 protocol and the DMX address is set via the control menu.

DATA CABLE (DMX Cable) REQUIREMENTS (For DMX and Master/Slave Operation)

Your fixture and your DMX controller require a standard 3pin or 5pin XLR connector for data input and data output (see figure below). If you are making your own cables, be sure to use two conductor, shielded digital DMX cable rated at 120 ohms; this cable is designed for DMX transmission and may be purchased from your Elation dealer or at most professional lighting retailers. Your cables should be made with a male and female XLR connector on either end of the cable. Also, remember that a DMX line must be daisy chained and cannot be split, unless using an approved DMX splitter such as **Elation's Opto Branch 4™, Opto Branch 8™, or DMX-Branch/4™**.

DMX Output
3-Pin XLR Socket



DMX Input
3-Pin XLR Socket

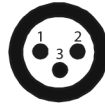

- 1: Ground
- 2: Data (-)
- 3: Data (+)

DMX Output
5-Pin XLR Socket



DMX Input
5-Pin XLR Socket

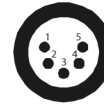

- 1: Ground
- 2: Data (-)
- 3: Data (+)
- 4: Open
- 5: Open



Be sure to follow the above figure when making your own cables. Do not use the ground lug on the XLR connector. Do not connect the cable's shield conductor to the ground lug or allow the shield conductor to come in contact with the XLR outer casing. Grounding the shield could cause a short circuit and erratic behavior.

DMX-512 CONTROLLER CONNECTION

Connect the provided XLR cable to the female XLR output of your controller and the other side to the male XLR input of the **SIXBAR 1000™**. The diagram below illustrates a typical DMX-512 connection when the fixture is in the **79 Channel Mode**. You can chain multiple panels together through serial linking. The cable that should be used is two conductor, shielded DMX cable with XLR input and output connectors. Always be sure daisy chain your in and out data connections, never split or "Y" your DMX connections unless you are using an approved DMX splitter such as **Elation's Opto Branch 4™, Opto Branch 8™, or DMX-Branch/4™**.

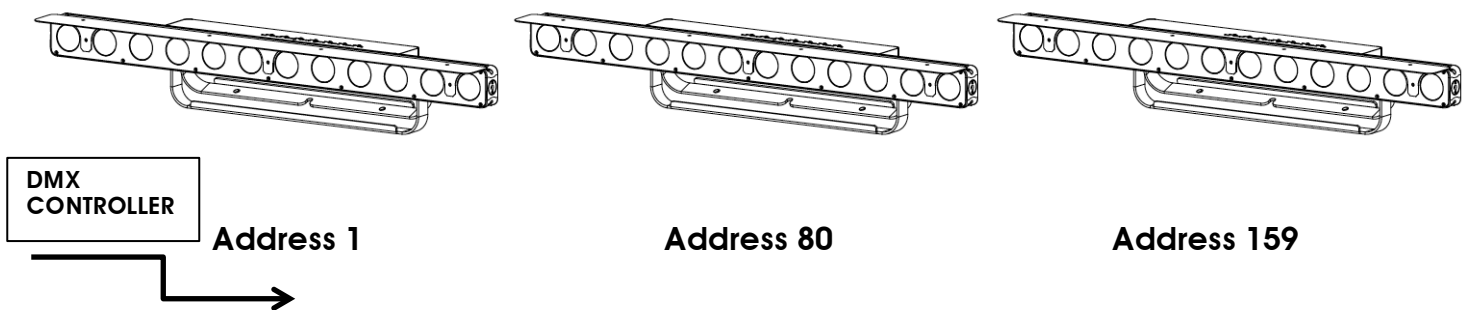

DMX-512 CONNECTION WITH DMX TERMINATOR

A DMX terminator should be used in all DMX lines especially in longer runs. The use of a terminator may avoid erratic behavior in your DMX line. A terminator is a 120 ohm 1/4 watt resistor that is connected between pins 2 and 3 of a male XLR connector (DATA + and DATA -). This fixture is inserted in the female XLR connector of the last fixture in your daisy chain to terminate the line. Using a line terminator will decrease the possibilities of erratic behavior.

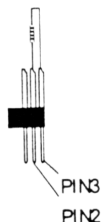
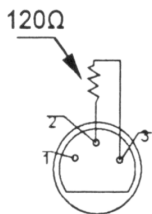

Termination reduces signal errors and avoids signal transmission problems and interference. It is always advisable to connect a DMX terminal, (Resistance 120 Ohm 1/4 W) between PIN 2 (DMX-) and PIN 3 (DMX +) of the last fixture.

5pin XLR DMX CONNECTORS

Some manufactures use 5pin XLR connectors for DATA transmission in place of 3pin. 5pin XLR fixtures may be implemented in a 3pin XLR DMX line. When inserting standard 5pin XLR connectors in to a 3pin line a cable adaptor must be used, these adaptors are readily available at most electric stores. The following chart details a proper cable conversion.

3-Pin XLR to 5-Pin XLR Conversion		
Conductor	3-Pin XLR Female (Out)	5-Pin XLR Male (In)
Ground/Shield	Pin 1	Pin 1
Data Compliment (- signal)	Pin 2	Pin 2
Data True (+ signal)	Pin 3	Pin 3
Not Used		Pin 4 - Do Not Use
Not Used		Pin 5 - Do Not Use

DMX ADDRESSING

All fixtures should be given a DMX starting address when using a DMX controller, so the correct fixture responds to the correct control signal. This digital starting address is the channel number from which the fixture starts to “listen” to the digital control information sent out from the DMX controller. The allocation of this starting DMX address is achieved by setting the correct DMX address on the digital display located on the back of the fixture.

You can set the same starting address for all fixtures or a group of fixtures, or set different address for each individual fixture. Be advised that setting all fixtures to the same DMX address will subsequently control all fixtures in the same fashion, in other words, changing the settings of one channel will affect all the fixtures simultaneously.

If you set each fixture to a different DMX address, each unit will start to “listen” to the channel number you have set, based on the quantity of control channels (DMX channels) of each fixture. That means changing the settings of one channel will only affect the selected fixture.

In the case of the **SIXBAR 1000™**, when in the **79 Channel Mode** you should set the starting DMX address of the first unit to 1, the second unit to 80 (1 + 79), the third unit to 159 (80 + 79), and so on.

Note: During start-up the **SIXBAR 1000™** will automatically detect whether a DMX data signal is being received or not. If the fixture is not receiving a DMX signal please check the following:

- The 3pin or 5pin XLR input plug (cable with DMX signal from controller) is not connected or is not inserted completely into the DMX input jack of the fixture.
- The DMX controller is switched off or defective.
- The DMX cable or connector is defective.
- A DMX terminator has been inserted into the last fixture in your DMX chain.

FIXTURE MENU

ON-BOARD SYSTEM MENU

The **SIXBAR 1000™** comes with an easy to navigate system menu. The next section will detail the functions of each command in the system menu.

LCD MENU CONTROL PANEL

The control panel (see image below) located on the top of the fixture allows you to access the main menu and make all necessary adjustments to the **SIXBAR 1000™**. During normal operation, pressing **MODE** button once will access the fixture's main menu. Once in the main menu you can navigate through the different functions and access the sub-menus with the **UP**, and **DOWN** buttons. Once you reach a field that requires adjusting, press the **ENTER** button to activate that field and use the **UP** and **DOWN** buttons to adjust the field. Pressing the **ENTER** button once more will confirm your setting. You may exit the main menu at any time without making any adjustments by pressing the **MODE** button.



NOTE: the LCD Menu Control Display will shut OFF and lockout after 30 seconds of no use. Press and hold the **MODE** button for 10 seconds to unlock the LCD display.

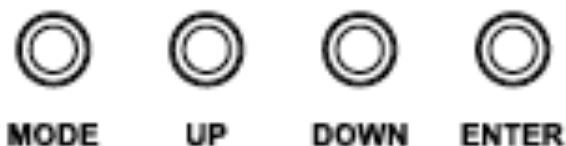

INFORMATION DISPLAYED DURING INITIAL POWER ON

When the fixture is initially powered ON, the display shows the following information:



**ELATION© SIXBAR 1000™
SYSTEM MENU**

Specifications are subject to change without any prior written notice.

MENU	OPTIONS / VALUES	DESCRIPTION
DMX MODE ADDR:xxx CH:xx	ADDR:001 - 512 CH:06, 07, 11, 13, 36, 72, 75, 79	Set DMX Address. Set DMX Channel Mode.
SLAVE M O D E		Set unit to Slave Mode.
AUTO RUN FQN:xx	FQN:01-99	Set the number of times each internal macro will repeat before moving to the next macro.
01.STATIC - 15.FLOW1	01-15	Select Internal Program Macro. See PROGRAM MACRO MENU for more details.
DimCurve	Standard, Stage, TV, Architec, Theatre	Set desired Dimming Curve.
Flip	ON, OFF	Set starting LED. See FLIP Section for more details.
NO DMX	Hold, Blackout, Program	Define how fixture reacts when NO DMX signal present.
Manual	R000-255 G000-255 B000-255 W000-255 A000-255 U000-255 STR:00-99	Set RGBWAU and Strobe Values manually.
Macros	00-63	Select Internal Color Macro. See COLOR MACRO MENU for more details.
Net Set Fix ID	Ser PIN Pass= 050	Enter Passcode to access Network Menus.
Fix ID IP Addr	000.000.000.000	Set IP address. (Need to enter Service PIN to access this menu)
Fix ID Ctr Addr	000.000.000.000	Set Subnet Mask. (Need to enter Service PIN to access this menu)
Fix ID Universe	000-255	Set DMX Universe number. (Need to enter Service PIN to access this menu)
Pro Set	K- Net, ArtNet (default)	Set Protocol (Kling-Net or ArtNet).
Net Swi	ON (default) , OFF	Set Ethernet switch.

**ELATION© SIXBAR 1000™
PRGRAM MACRO MENU**

Specifications are subject to change without any prior written notice.

MACRO	OPTIONS / VALUES	DESCRIPTION
01.STATIC	CL:RGB F00-99	
02.DREAM	Speed01-99 Flash00-99	
03.METOR	Speed01-99 Flash00-99	
04.FADE	Speed01-99 Flash00-99	
05.CHANG	Speed01-99 Flash00-99	
06.FLOW1	Speed01-99 Flash00-99	
07.FLOW2	Speed01-99 Flash00-99	
08.FLOW3	Speed01-99 Flash00-99	
09.FLOW4	Speed01-99 Flash00-99	
10.FLOW5	Speed01-99 Flash00-99	
11.FLOW6	Speed01-99 Flash00-99	
12.FLOW7	Speed01-99 Flash00-99	
13.FLOW8	Speed01-99 Flash00-99 C1:RGB C2:RGB	
14.FLOW 9	Speed01-99 Flash00-99 C1:RGB C2:RGB	
15.FLOW 10	Speed01-99 Flash00-99	

DIMMING CURVES

The **DimCurve** menu allows you to select one of the following preset dimming curves: **Standard, Stage, TV, Architectural, Theatre, or Default.**

(See diagram below for more details)

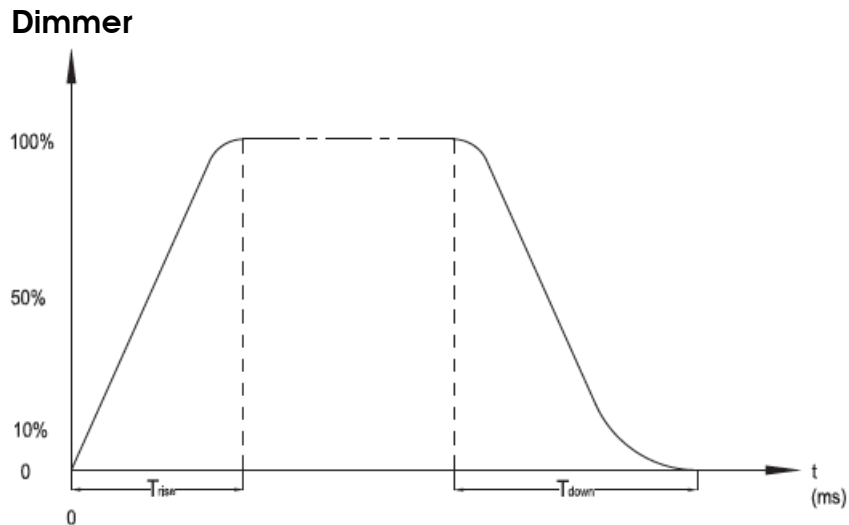

Ramp Effect	OS (Fade Time)		1S (Fade Time)	
	T _{rise} (ms)	T _{down} (ms)	T _{rise} (ms)	T _{down} (ms)
Standard	0	0	0	0
Stage	780	1100	1540	1660
TV	1180	1520	1860	1940
Architectural	1380	1730	2040	2120
Theatre	1580	1940	2230	2280

PIXEL FLIP

Select the desired starting COB module and chase direction from one of the following modes below via **UP/DOWN** buttons and then press **ENTER** to confirm.

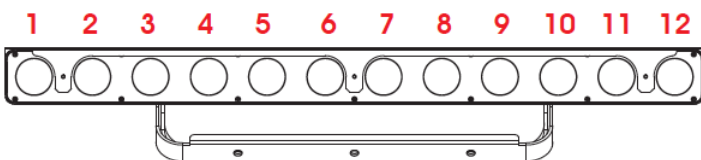

Flip = OFF

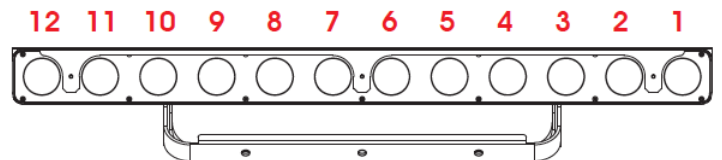

Flip = ON

ELATION© SIXBAR 1000™ COLOR MACRO MENU	
Specifications are subject to change without any prior written notice.	
MACRO	OPTIONS / VALUES
00. OFF	0-3
01. RED	4-7
02. GREEN	8-11
03. BLUE	12-15
04. WHITE	16-19
05. AMBER	20-23
06. UV	24-27
07. RED + GREEN	28-31
08. RED + BLUE	32-35
09. RED + WHITE	36-39
10. RED + AMBER	40-43
11. RED + UV	44-47
12. GREEN + BLUE	48-51
13. GREEN + WHITE	52-55
14. GREEN + AMBER	56-59
15. GREEN + UV	60-63
16. BLUE + WHITE	64-67
17. BLUE + AMBER	68-71
18. BLUE + UV	72-75
19. WHITE + AMBER	76-79
20. WHITE + UV	80-83
21. AMBER + UV	84-87
22. RED + GREEN + BLUE	88-91
23. RED + GREEN + WHITE	92-95
24. RED + GREEN + AMBER	96-99
25. RED + GREEN + UV	100-103
26. RED + BLUE + WHITE	104-107
27. RED + BLUE + AMBER	108-111
28. RED + BLUE + UV	112-115
29. RED + WHITE + AMBER	116-119
30. RED + WHITE + UV	120-123
31. RED + AMBER + UV	124-127
32. GREEN + BLUE + WHITE	128-131
33. GREEN + BLUE + AMBER	132-135
34. GREEN + BLUE + UV	136-139
35. GREEN + WHITE + AMBER	140-143
36. GREEN + WHITE + UV	144-147
37. GREEN + AMBER + UV	148-151
38. BLUE + WHITE + AMBER	152-155
39. BLUE + WHITE + UV	156-159

ELATION© SIXBAR 1000™ COLOR MACRO MENU	
Specifications are subject to change without any prior written notice.	
MACRO	OPTIONS / VALUES
40. BLUE + AMBER + UV	160-163
41. WHITE + AMBER + UV	164-167
42. RED + GREEN + BLUE + WHITE	168-171
43. RED + GREEN + BLUE + WHITE	172-175
44. RED + GREEN + BLUE + UV	176-179
45. RED + GREEN + WHITE + AMBER	180-183
46. RED + GREEN + WHITE + UV	184-187
47. RED + GREEN + AMBER + UV	188-191
48. RED + BLUE + WHITE + AMBER	192-195
49. RED + BLUE + WHITE + UV	196-199
50. RED + BLUE + AMBER + UV	200-203
51. RED + WHITE + AMBER + UV	204-207
52. GREEN + BLUE + WHITE + AMBER	208-211
53. GREEN + BLUE + WHITE + UV	212-215
54. GREEN + BLUE + AMBER + UV	216-219
55. GREEN + WHITE + AMBER + UV	220-223
56. BLUE + WHITE + AMBER + UV	224-227
57. RED + GREEN + BLUE + WHITE + AMBER	228-231
58. RED + GREEN + BLUE + WHITE + UV	232-235
59. RED + GREEN + BLUE + AMBER + UV	236-239
60. RED + GREEN + WHITE + AMBER + UV	240-243
61. RED + BLUE + WHITE + AMBER + UV	244-247
62. GREEN + BLUE + WHITE + AMBER + UV	248-251
63. RED + GREEN + BLUE + WHITE + AMBER + UV	252-255

 **DMX WORKSHOP™ (alternative software option to configure network settings)**

DMX-Workshop™ is a fully featured network management, analysis, configuration and diagnostics tool for Art-Net networks. It can be used to configure the Ethernet network settings on this fixture remotely such as the IP Address, Subnet Mask, and the DMX Universe. This software application is Windows XP™ and Windows 7™ compatible and is free of charge and available via download here. (See link below)

http://artisticlicence.com/index.php?mode=products&sub=overview&action=&product_id=351

DMX CHANNEL FUNCTIONS AND VALUES

ELATION© SIXBAR 1000™									
DMX Channel Values / Functions Version 1 (79 DMX Channels)									
Specifications are subject to change without any prior written notice.									
*Control of LEDs depends on the Pixel Flip setting.									
DMX CHANNEL MODE								VALUE	FUNCTION
6CH	7CH	11CH	13CH	36CH	72CH	75CH	79CH		
1	1	1	1						RED LED - All LEDs [1-12]
								0-255	Red (0-Black - 255-100%)
2	2	2	2						GREEN LED - All LEDs [1-12]
								0-255	Green (0-Black - 255-100%)
3	3	3	3						BLUE LED - All LEDs [1-12]
								0-255	Blue (0-Black - 255-100%)
4	4	4	4						WHITE LED - All LEDs [1-12]
								0-255	White (0-Black - 255-100%)
5	5	5	5						AMBER LED - All LEDs [1-12]
								0-255	Amber (0-Black - 255-100%)
6	6	6	6						UV LED - All LEDs [1-12]
								0-255	UV (0-Black - 255-100%)
				1					RED LED - All LEDs [1-2]
								0-255	Red (0-Black - 255-100%)
				2					GREEN LED - All LEDs [1-2]
								0-255	Green (0-Black - 255-100%)
				3					BLUE LED - All LEDs [1-2]
								0-255	Blue (0-Black - 255-100%)
				4					WHITE LED - All LEDs [1-2]
								0-255	White (0-Black - 255-100%)
				5					AMBER LED - All LEDs [1-2]
								0-255	Amber (0-Black - 255-100%)
				6					UV LED - All LEDs [1-2]
								0-255	UV (0-Black - 255-100%)
				7					RED LED - All LEDs [3-4]
								0-255	Red (0-Black - 255-100%)
				8					GREEN LED - All LEDs [3-4]
								0-255	Green (0-Black - 255-100%)
				9					BLUE LED - All LEDs [3-4]
									Blue (0-Black - 255-100%)
				10					WHITE LED - All LEDs [3-4]
								0-255	White (0-Black - 255-100%)
				11					AMBER LED - All LEDs [3-4]
								0-255	Amber (0-Black - 255-100%)
				12					UV LED - All LEDs [3-4]
								0-255	UV (0-Black - 255-100%)

ELATION© SIXBAR 1000™									
DMX Channel Values / Functions Version 1 (79 DMX Channels)									
Specifications are subject to change without any prior written notice.									
*Control of LEDs depends on the Pixel Flip setting.									
DMX CHANNEL MODE								VALUE	FUNCTION
6CH	7CH	11CH	13CH	36CH	72CH	75CH	79CH		
				13					RED LED - All LEDs [5-6]
								0-255	Red (0-Black - 255-100%)
				14					GREEN LED - All LEDs [5-6]
								0-255	Green (0-Black - 255-100%)
				15					BLUE LED - All LEDs [5-6]
								0-255	Blue (0-Black - 255-100%)
				16					WHITE LED - All LEDs [5-6]
								0-255	White (0-Black - 255-100%)
				17					AMBER LED - All LEDs [5-6]
								0-255	Amber (0-Black - 255-100%)
				18					UV LED - All LEDs [5-6]
								0-255	UV (0-Black - 255-100%)
				19					RED LED - All LEDs [7-8]
								0-255	Red (0-Black - 255-100%)
				20					GREEN LED - All LEDs [7-8]
								0-255	Green (0-Black - 255-100%)
				21					BLUE LED - All LEDs [7-8]
								0-255	Blue (0-Black - 255-100%)
				22					WHITE LED - All LEDs [7-8]
								0-255	White (0-Black - 255-100%)
				23					AMBER LED - All LEDs [7-8]
								0-255	Amber (0-Black - 255-100%)
				24					UV LED - All LEDs [7-8]
								0-255	UV (0-Black - 255-100%)
				25					RED LED - All LEDs [9-10]
								0-255	Red (0-Black - 255-100%)
				26					GREEN LED - All LEDs [9-10]
								0-255	Green (0-Black - 255-100%)
				27					BLUE LED - All LEDs [9-10]
								0-255	Blue (0-Black - 255-100%)
				28					WHITE LED - All LEDs [9-10]
								0-255	White (0-Black - 255-100%)
				29					AMBER LED - All LEDs [9-10]
								0-255	Amber (0-Black - 255-100%)
				30					UV LED - All LEDs [9-10]
								0-255	UV (0-Black - 255-100%)

ELATION© SIXBAR 1000™									
DMX Channel Values / Functions Version 1 (79 DMX Channels)									
Specifications are subject to change without any prior written notice.									
*Control of LEDs depends on the Pixel Flip setting.									
DMX CHANNEL MODE								VALUE	FUNCTION
6CH	7CH	11CH	13CH	36CH	72CH	75CH	79CH		
				31					RED LED - All LEDs [11-12]
								0-255	Red (0-Black - 255-100%)
				32					GREEN LED - All LEDs [11-12]
								0-255	Green (0-Black - 255-100%)
				33					BLUE LED - All LEDs [11-12]
								0-255	Blue (0-Black - 255-100%)
				34					WHITE LED - All LEDs [11-12]
								0-255	White (0-Black - 255-100%)
				35					AMBER LED - All LEDs [11-12]
								0-255	Amber (0-Black - 255-100%)
				36					UV LED - All LEDs [11-12]
								0-255	UV (0-Black - 255-100%)
					1	1	1		RED LED - LED [1]
								0-255	Red (0-Black - 255-100%)
					2	2	2		GREEN LED - LED [1]
								0-255	Green (0-Black - 255-100%)
					3	3	3		BLUE LED - LED [1]
								0-255	Blue (0-Black - 255-100%)
					4	4	4		WHITE LED - LED [1]
								0-255	White (0-Black - 255-100%)
					5	5	5		AMBER LED - LED [1]
								0-255	Amber (0-Black - 255-100%)
					6	6	6		UV LED - LED [1]
								0-255	UV (0-Black - 255-100%)
					7	7	7		RED LED - LED [2]
								0-255	Red (0-Black - 255-100%)
					8	8	8		GREEN LED - LED [2]
								0-255	Green (0-Black - 255-100%)
					9	9	9		BLUE LED - LED [2]
								0-255	Blue (0-Black - 255-100%)
					10	10	10		WHITE LED - LED [2]
								0-255	White (0-Black - 255-100%)
					11	11	11		AMBER LED - LED [2]
								0-255	Amber (0-Black - 255-100%)

ELATION© SIXBAR 1000™									
DMX Channel Values / Functions Version 1 (79 DMX Channels)									
Specifications are subject to change without any prior written notice.									
*Control of LEDs depends on the Pixel Flip setting.									
DMX CHANNEL MODE								VALUE	FUNCTION
6CH	7CH	11CH	13CH	36CH	72CH	75CH	79CH		
					12	12	12		UV LED - LED [2]
								0-255	UV (0-Black - 255-100%)
					13	13	13		RED LED - LED [3]
								0-255	Red (0-Black - 255-100%)
					14	14	14		GREEN LED - LED [3]
								0-255	Green (0-Black - 255-100%)
					15	15	15		BLUE LED - LED [3]
								0-255	Blue (0-Black - 255-100%)
					16	16	16		WHITE LED - LED [3]
								0-255	White (0-Black - 255-100%)
					17	17	17		AMBER LED - LED [3]
								0-255	Amber (0-Black - 255-100%)
					18	18	18		UV LED - LED [3]
								0-255	UV (0-Black - 255-100%)
					19	19	19		RED LED - LED [4]
								0-255	Red (0-Black - 255-100%)
					20	20	20		GREEN LED - LED [4]
								0-255	Green (0-Black - 255-100%)
					21	21	21		BLUE LED - LED [4]
								0-255	Blue (0-Black - 255-100%)
					22	22	22		WHITE LED - LED [4]
								0-255	White (0-Black - 255-100%)
					23	23	23		AMBER LED - LED [4]
								0-255	Amber (0-Black - 255-100%)
					24	24	24		UV LED - LED [4]
								0-255	UV (0-Black - 255-100%)
					25	25	25		RED LED - LED [5]
								0-255	Red (0-Black - 255-100%)
					26	26	26		GREEN LED - LED [5]
								0-255	Green (0-Black - 255-100%)
					27	27	27		BLUE LED - LED [5]
								0-255	Blue (0-Black - 255-100%)
					28	28	28		WHITE LED - LED [5]
								0-255	White (0-Black - 255-100%)
					29	29	29		AMBER LED - LED [5]
								0-255	Amber (0-Black - 255-100%)
					30	30	30		UV LED - LED [5]
								0-255	UV (0-Black - 255-100%)

ELATION© SIXBAR 1000™									
DMX Channel Values / Functions Version 1 (79 DMX Channels)									
Specifications are subject to change without any prior written notice.									
*Control of LEDs depends on the Pixel Flip setting.									
DMX CHANNEL MODE								VALUE	FUNCTION
6CH	7CH	11CH	13CH	36CH	72CH	75CH	79CH		
					31	31	31		RED LED - LED [6]
								0-255	Red (0-Black - 255-100%)
					32	32	32		GREEN LED - LED [6]
								0-255	Green (0-Black - 255-100%)
					33	33	33		BLUE LED - LED [6]
								0-255	Blue (0-Black - 255-100%)
					34	34	34		WHITE LED - LED [6]
								0-255	White (0-Black - 255-100%)
					35	35	35		AMBER LED - LED [6]
								0-255	Amber (0-Black - 255-100%)
					36	36	36		UV LED - LED [6]
								0-255	UV (0-Black - 255-100%)
					37	37	37		RED LED - LED [7]
								0-255	Red (0-Black - 255-100%)
					38	38	38		GREEN LED - LED [7]
								0-255	Green (0-Black - 255-100%)
					39	39	39		BLUE LED - LED [7]
								0-255	Blue (0-Black - 255-100%)
					40	40	40		WHITE LED - LED [7]
								0-255	White (0-Black - 255-100%)
					41	41	41		AMBER LED - LED [7]
								0-255	Amber (0-Black - 255-100%)
					42	42	42		UV LED - LED [7]
								0-255	UV (0-Black - 255-100%)
					43	43	43		RED LED - LED [8]
								0-255	Red (0-Black - 255-100%)
					44	44	44		GREEN LED - LED [8]
								0-255	Green (0-Black - 255-100%)
					45	45	45		BLUE LED - LED [8]
								0-255	Blue (0-Black - 255-100%)
					46	46	46		WHITE LED - LED [8]
								0-255	White (0-Black - 255-100%)
					47	47	47		AMBER LED - LED [8]
								0-255	Amber (0-Black - 255-100%)
					48	48	48		UV LED - LED [8]
								0-255	UV (0-Black - 255-100%)

ELATION© SIXBAR 1000™									
DMX Channel Values / Functions Version 1 (79 DMX Channels)									
Specifications are subject to change without any prior written notice.									
*Control of LEDs depends on the Pixel Flip setting.									
DMX CHANNEL MODE								VALUE	FUNCTION
6CH	7CH	11CH	13CH	36CH	72CH	75CH	79CH		
					49	49	49		RED LED - LED [9]
								0-255	Red (0-Black - 255-100%)
					50	50	50		GREEN LED - LED [9]
								0-255	Green (0-Black - 255-100%)
					51	51	51		BLUE LED - LED [9]
								0-255	Blue (0-Black - 255-100%)
					52	52	52		WHITE LED - LED [9]
								0-255	White (0-Black - 255-100%)
					53	53	53		AMBER LED - LED [9]
								0-255	Amber (0-Black - 255-100%)
					54	54	54		UV LED - LED [9]
								0-255	UV (0-Black - 255-100%)
					55	55	55		RED LED - LED [10]
								0-255	Red (0-Black - 255-100%)
					56	56	56		GREEN LED - LED [10]
								0-255	Green (0-Black - 255-100%)
					57	57	57		BLUE LED - LED [10]
								0-255	Blue (0-Black - 255-100%)
					58	58	58		WHITE LED - LED [10]
								0-255	White (0-Black - 255-100%)
					59	59	59		AMBER LED - LED [10]
								0-255	Amber (0-Black - 255-100%)
					60	60	60		UV LED - LED [10]
								0-255	UV (0-Black - 255-100%)
					61	61	61		RED LED - LED [11]
								0-255	Red (0-Black - 255-100%)
					62	62	62		GREEN LED - LED [11]
								0-255	Green (0-Black - 255-100%)
					63	63	63		BLUE LED - LED [11]
								0-255	Blue (0-Black - 255-100%)
					64	64	64		WHITE LED - LED [11]
								0-255	White (0-Black - 255-100%)
					65	65	65		AMBER LED - LED [11]
								0-255	Amber (0-Black - 255-100%)
					66	66	66		UV LED - LED [11]
								0-255	UV (0-Black - 255-100%)

ELATION© SIXBAR 1000™									
DMX Channel Values / Functions Version 1 (79 DMX Channels)									
Specifications are subject to change without any prior written notice.									
*Control of LEDs depends on the Pixel Flip setting.									
DMX CHANNEL MODE								VALUE	FUNCTION
6CH	7CH	11CH	13CH	36CH	72CH	75CH	79CH		
					67	67	67		RED LED - LED [12]
								0-255	Red (0-Black - 255-100%)
					68	68	68		GREEN LED - LED [12]
								0-255	Green (0-Black - 255-100%)
					69	69	69		BLUE LED - LED [12]
								0-255	Blue (0-Black - 255-100%)
					70	70	70		WHITE LED - LED [12]
								0-255	White (0-Black - 255-100%)
					71	71	71		AMBER LED - LED [12]
								0-255	Amber (0-Black - 255-100%)
					72	72	72		UV LED - LED [12]
								0-255	UV (0-Black - 255-100%)
	7	7	7			73	73		MASTER DIMMER
								0-255	0 to 100%
									STROBE
								0-31	NO Function
								32-63	LEDs ON
								64-95	Strobe Effect SLOW to FAST
		8	8			74	74	96-127	LEDs ON
								128-159	Pulse Effect In Sequence SLOW to FAST
								160-191	LEDs ON
								192-223	Random Strobe Effect SLOW to FAST
								224-255	LEDs ON

ELATION© SIXBAR 1000™									
DMX Channel Values / Functions Version 1 (79 DMX Channels)									
Specifications are subject to change without any prior written notice.									
*Control of LEDs depends on the Pixel Flip setting.									
DMX CHANNEL MODE								VALUE	FUNCTION
6CH	7CH	11CH	13CH	36CH	72CH	75CH	79CH		
									COLOR MACROS
								0-3	NO Function
								4-7	Color Macro 01
								8-11	Color Macro 02
								12-15	Color Macro 03
								16-19	Color Macro 04
								20-23	Color Macro 05
								24-27	Color Macro 06
								28-31	Color Macro 07
								32-35	Color Macro 08
								36-39	Color Macro 09
								40-43	Color Macro 10
								44-47	Color Macro 11
								48-51	Color Macro 12
								52-55	Color Macro 13
								56-59	Color Macro 14
			9				75	60-63	Color Macro 15
								64-67	Color Macro 16
								68-71	Color Macro 17
								72-75	Color Macro 18
								76-79	Color Macro 19
								80-83	Color Macro 20
								84-87	Color Macro 21
								88-91	Color Macro 22
								92-95	Color Macro 23
								96-99	Color Macro 24
								100-103	Color Macro 25
								104-107	Color Macro 26
								108-111	Color Macro 27
								112-115	Color Macro 28
								116-119	Color Macro 29
								120-123	Color Macro 30
								124-127	Color Macro 31
								128-131	Color Macro 32

ELATION© SIXBAR 1000™									
DMX Channel Values / Functions Version 1 (79 DMX Channels)									
Specifications are subject to change without any prior written notice.									
*Control of LEDs depends on the Pixel Flip setting.									
DMX CHANNEL MODE								VALUE	FUNCTION
6CH	7CH	11CH	13CH	36CH	72CH	75CH	79CH		
								132-135	Color Macro 33
								136-139	Color Macro 34
								140-143	Color Macro 35
								144-1147	Color Macro 36
								148-151	Color Macro 37
								152-155	Color Macro 38
								156-159	Color Macro 39
								160-163	Color Macro 40
								164-167	Color Macro 41
								168-171	Color Macro 42
								172-175	Color Macro 43
								176-179	Color Macro 44
								180-183	Color Macro 45
								184-187	Color Macro 46
								188-191	Color Macro 47
			9				75	192-195	Color Macro 48
								196-199	Color Macro 49
								200-203	Color Macro 50
								204-207	Color Macro 51
								208-211	Color Macro 52
								212-215	Color Macro 53
								216-219	Color Macro 54
								220-223	Color Macro 55
								224-227	Color Macro 56
								228-231	Color Macro 57
								232-235	Color Macro 58
								236-239	Color Macro 59
								240-243	Color Macro 60
								244-247	Color Macro 61
								248-251	Color Macro 62
								252-255	Color Macro 63

ELATION© SIXBAR 1000™								VALUE	FUNCTION
DMX Channel Values / Functions Version 1 (79 DMX Channels)									
Specifications are subject to change without any prior written notice.									
*Control of LEDs depends on the Pixel Flip setting.									
DMX CHANNEL MODE									
6CH	7CH	11CH	13CH	36CH	72CH	75CH	79CH		
		9	10				76		PROGRAM MACROS
								0-10	NO Function
								11-26	Program 01 - DREAM
								27-43	Program 02 - METEOR
								44-60	Program 03 - FADE
								61-76	Program 04 - CHANGE
								77-93	Program 05 - FLOW 1
								94-110	Program 06 - FLOW 2
								111-126	Program 07 - FLOW 3
								127-143	Program 08 - FLOW 4
								144-160	Program 09 - FLOW 5
								161-176	Program 10 - FLOW 6
								177-193	Program 11 - FLOW 7
								194-210	Program 12 - FLOW 8
								211-226	Program 13 - FLOW 9
								227-255	NO Function
		10	11				77		PROGRAM SPEED
								0-255	Program Speed SLOW to FAST
		11	12				78		PROGRAM FADE
								0-255	Program Fade SLOW to FAST
			13			75	79		DIMMING CURVE MODES
								0-20	STANDARD
								21-40	STAGE
								41-60	TV
								61-80	ARCHITECTURAL
								81-100	THEATRE
								101-255	Default to Unit Setting

CLEANING AND MAINTENANCE



C A U T I O N

Disconnect power before cleaning or maintenance.

CLEANING

Frequent cleaning is recommended to insure proper function, optimized light output, and an extended life. The frequency of cleaning depends on the environment in which the fixture operates: damp, smoky or particularly dirty environments can cause greater accumulation of dirt on the fixture's optics.

- Clean the external lens surface at least every 20 days with a soft cloth to avoid dirt/debris accumulation.
- Never use alcohol, solvents, or ammonia based cleaners.

MAINTENANCE

Regular inspections are recommended to insure proper function and extended life. There are no user serviceable parts inside this fixture, please refer all other service issues to an authorized Elation service technician. Should you need any spare parts, please order genuine parts from your local Elation dealer.

Please refer to the following points during routine inspections:

- A detailed electric check by an approved electrical engineer every three months, to make sure the circuit contacts are in good condition and prevent overheating.
- Be sure all screws and fasteners are securely tightened at all times. Loose screws may fall out during normal operation resulting in damage or injury as larger parts could fall.
- Check for any deformations on the housing, color lenses, rigging hardware and rigging points (ceiling, suspension, trussing). Deformations in the housing could allow for dust to enter into the fixture. Damaged rigging points or unsecured rigging could cause the fixture to fall and seriously injure a person(s).
- Electric power supply cables must not show any damage, material fatigue or sediments. Never remove the ground prong from the power cable.

TECHNICAL SPECIFICATIONS

FEATURES

30° Beam Angle
ArtNet and Kling-NET Support
RDM - Remote Device Management
Individual LED Control
Variable Dimming Curve Modes
Multiple Unit Power Linking
Rugged Die-Cast Aluminum Exterior
Flicker Free Operation for TV and FILM

SOURCE

(12) 12W 6-in-1 RGBAW+UV LEDs
100,000 Hour Average LED Life

EFFECTS

Strobe and Chase Effects
Individual LED Control
Variable and Selectable Dimming Curves

CONTROL / CONNECTIONS

8 DMX Channel Modes (6 / 7 / 11 / 13 / 36 / 72 / 75 / 79)
4 Button Control Panel and LCD Menu Display
ArtNet + KlingNET Protocol Support
RDM (Remote Device Management)
(2) RJ45 Ports
3pin and 5pin DMX In/Out
powerCON Power In/Out

SIZE / WEIGHT

Length: 35.4" (900mm)
Width: 8.1" (206.4mm) *with included shield
Vertical Height: 6.1" (155mm)
Weight: 16.0 lbs. (7.3 kg)

ELECTRICAL / THERMAL

AC 110-240V - 50/60Hz
145W Max Power Consumption
Power Linking: 6pcs @110V / 15pcs @240V
5°F to 113°F (-15°C to 45°C)

APPROVALS / RATINGS

CE | IP20

Please Note: Specifications and improvements in the design of this unit and this manual are subject to change without any prior written notice.

PHOTOMETRIC DATA

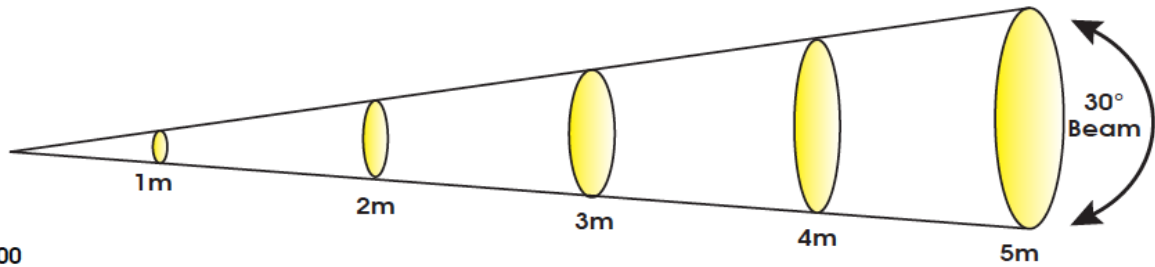

SIXBAR 1000

Distance	1 m	3.3 ft	2 m	6.6 ft	3 m	9.8 ft	4 m	13.1 ft	5 m	16.4 ft
30° Beam Diameter	0.52	1.7	1.05	3.4	1.58	5.2	2.13	7.0	2.66	8.7
Photometrics	lux	fc	lux	fc	lux	fc	lux	fc	lux	fc
RED LEDs	1,080	100	490	46	274	25	169	16	114	11
GREEN LEDs	2,140	199	1,030	96	553	51	337	31	228	21
BLUE LEDs	2,430	226	1,179	110	652	61	399	37	269	25
WHITE LEDs	2,700	251	1,240	115	683	63	406	38	280	26
AMBER LEDs	1,065	99	490	46	265	25	161	15	116	11
UV LEDs	590	55	255	24	136	13	85	8	56	5
FULL ON	8,500	790	3,660	340	2,040	190	1,290	120	878	82

DIMENSIONAL DRAWINGS

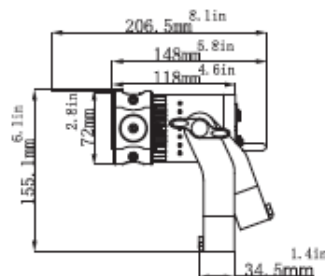
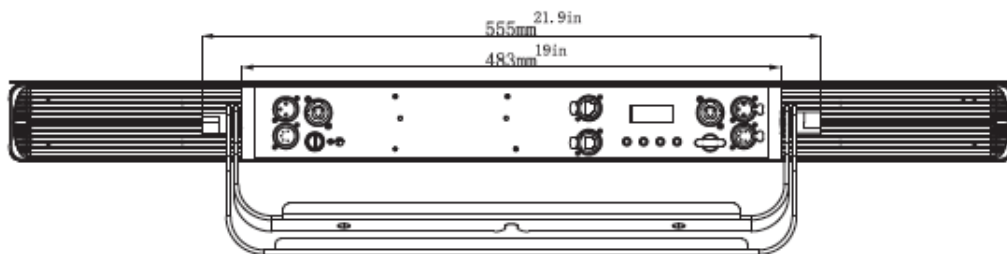
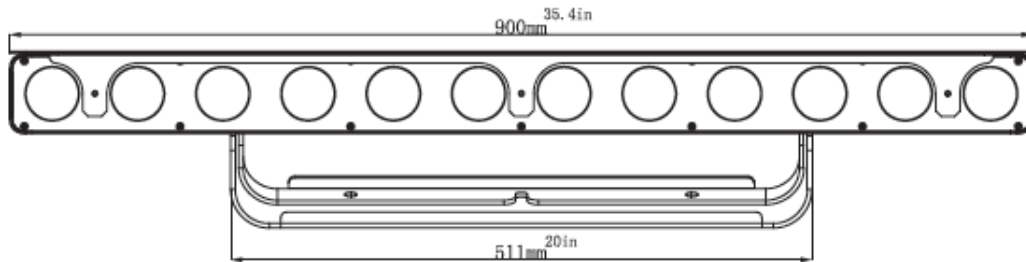

OPTIONAL ACCESSORIES

ORDER CODE	ITEM
TRIGGER CLAMP	Heavy Duty Wrap Around Hook Style Clamp
EWDMSYSTEM	Wireless DMX System (1 Transmitter, 1 Receiver)
EWDMXT	Wireless DMX Transmitter
EWDMXR	Wireless DMX Receiver
PLC3	3' (1m) powerCON PRO Link Cable
AC3PDMX5PRO	5 ft. (1.5m) 3pin PRO DMX Cable
AC5PDMX5PRO	5 ft. (1.5m) 5pin PRO DMX Cable
CAT005	5' (1.5m) CAT6 Ethercon Cable
	Additional Cable Lengths Available

